

**SURGICAL  
TECHNIQUE**

PRECISION SPINE  
**REFORM<sup>®</sup>**  
POCT  
SYSTEM



PRECISION SPINE<sup>®</sup>  
*Discover the Difference*



# TABLE OF CONTENTS

<b>REFORM® POCT SYSTEM OVERVIEW</b>	<b>3</b>
<b>DESIGN FEATURES</b>	<b>4 - 9</b>
<b>CASES &amp; PART NUMBERS</b>	<b>10 - 19</b>
<i>Standard Implant Case</i>	10
<i>Add-On Implant Case – Top Tray</i>	11
<i>Add-On Implant Case – Bottom Tray</i>	12
<i>Standard Instrument Case – Top Tray</i>	13
<i>Standard Instrument Case – Bottom Tray</i>	14
<i>Add-On Instrument Case – Top Tray</i>	15
<i>Add-On Instrument Case – Bottom Tray</i>	16
<i>Occipital Implant Case</i>	17
<i>Occipital Instrument Case – Top Tray</i>	18
<i>Occipital Instrument Case – Bottom Tray</i>	19
<i>Special Order Implants &amp; Instruments</i>	20
<b>SURGICAL TECHNIQUE</b>	<b>21 - 30</b>
<i>Pre-Operating Planning</i>	21
<i>Polyaxial Screw Placement</i>	21
<i>Rod Placement</i>	23
<i>Rod Reduction</i>	24
<i>Final Tightening</i>	25
<i>Hook Placement</i>	25
<i>Cross-Connector Attachment</i>	26
<i>Occipital Plate Size Selection &amp; Positioning</i>	28
<i>Plate Contouring</i>	29
<i>Occipital Plate &amp; Polyaxial Screw Placement</i>	30
<i>Occipital Rod Placement, Reduction &amp; Final Tightening</i>	31
<i>System Removal</i>	31
<b>INDICATIONS, CONTRAINDICATIONS POTENTIAL ADVERSE EFFECTS &amp; WARNINGS</b>	<b>32</b>

# Reform<sup>®</sup> POCT System

## OVERVIEW

The Reform POCT System is a posterior spinal fixation system intended for fusion of the Occipital, Cervical, and Thoracic regions of the spine (Occiput-T3). The system consists of a variety of rods, occipital plates, occipital screws, polyaxial screws, cross-connectors, lateral offset, domino connectors, and hooks to achieve an implant construct that closely matches patient anatomy. The Reform POCT System implants are fabricated from titanium, titanium alloy, or cobalt chromium alloys as described by standards such as ASTM F136, ASTM F1537, or ISO 5832-3. Implants made from medical grade titanium, medical grade titanium alloy, and medical grade cobalt chromium may be used together, however, should not be used with stainless steel. The system also includes the instruments necessary for inserting and securing the implants. The components are supplied clean and "NON-STERILE". All implants are single use only and should not be reused under any circumstances.

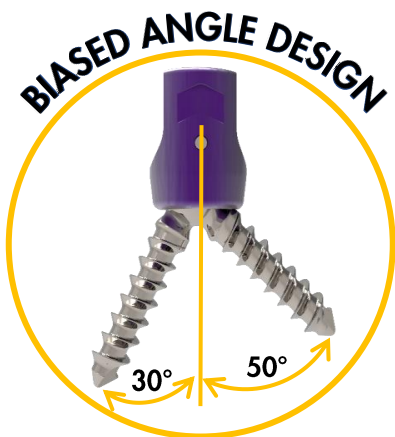

# DESIGN FEATURES

## INTRAOPERATIVE FLEXIBILITY

- 10° Screw Angulation

## POLYAXIAL SCREWS

- Standard Angle:  $\pm 30^\circ$
- Bias Angle Relief:  $50^\circ \times 20^\circ$  cone

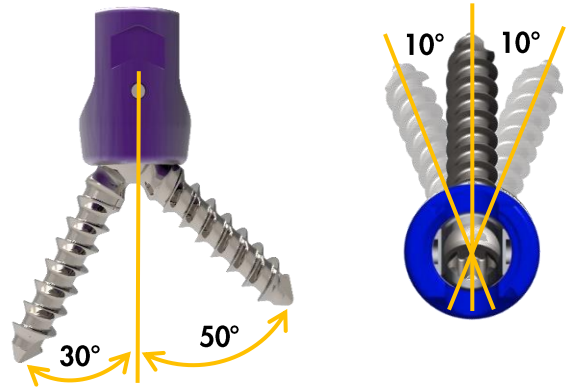

## STANDARD POLYAXIAL SCREW SIZE RANGES

Diameter	Color	Length
3.5mm	Dark Blue	8-30mm (2mm increments); 35mm, 40mm
4.0mm	Gold	8-30mm (2mm increments); 35mm, 40mm
4.5mm	Purple	20-50mm (5mm increments) *
5.0mm	Bronze	20-50mm (5mm increments) *
5.3mm	Silver	20-50mm (5mm increments) *

\* 14, 16 & 18mm Available on Special Order

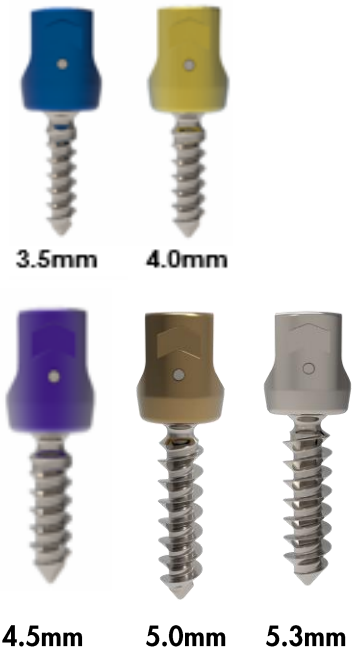

## SMOOTH SHANK POLYAXIAL SCREW SIZE RANGES

Diameter	Color	Length
3.5mm	Green	20-34mm (2mm increments)
4.0mm	Purple	20-34mm (2mm increments) *

\* 36, 38 & 40mm Available on Special Order

Fixed Thread Length – 16mm

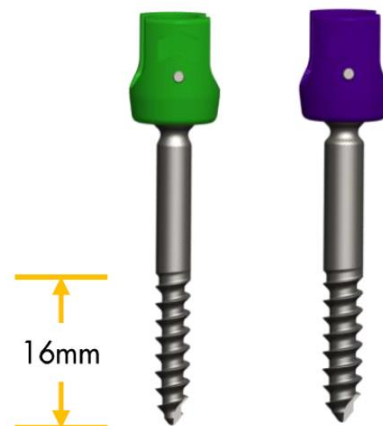

# DESIGN FEATURES

## STABILIZATION RODS

### Standard Rods

Material	Diameter	Length
Titanium (Straight)	3.5mm	20-80mm (10mm increments) 120, 240 & 350mm
Cobalt Chrome	3.5mm	80, 120, 240 & 350mm
Titanium (Lordotic)	3.5mm	60, 80 & 100mm

### Transition Rods

Material	Diameter	Length
Titanium & Cobalt Chrome	3.5 – 5.5mm	250 & 550mm *

\* 650mm Available on Special Order



## CROSS-CONNECTORS

- Rod-to-Rod and Head-to-Head Orientations
- $\pm 30^\circ$  of Rotation
- $\pm 30^\circ$  of Angulation

### Size Range

Size	Color
25-27mm	Natural Titanium
27-30mm	Magenta
30-36mm	Gold
35-46mm	Green
35-66mm	Dark Blue

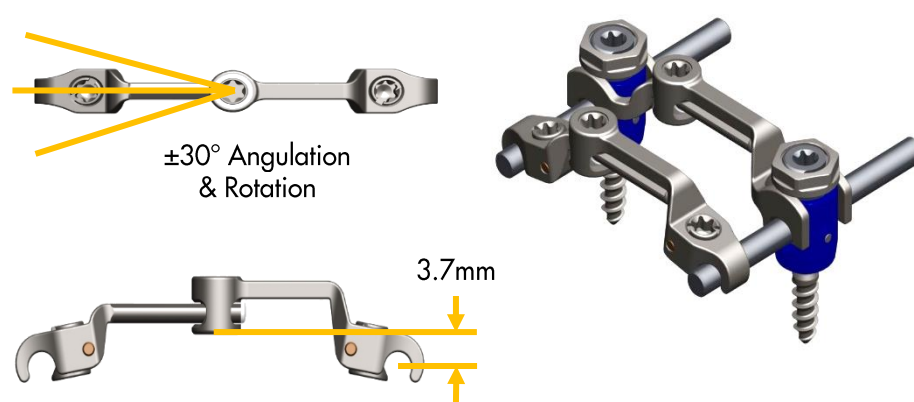

## CAP SCREWS

- Standard Cap Screw
- Head-to-Head Cross-connector Cap Screw
- Head-to-Head Cross-connector Locking Cap



# DESIGN FEATURES

## LATERAL OFFSETS

- Closed and Open (Top-loading) Orientations
- Offset Length: 15 & 25mm

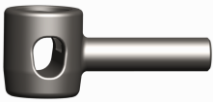

Closed



Open

## DOMINOES

- Parallel Orientations:  
Closed-Closed, Open-Closed, Open-Open
- Axial Orientations:  
Closed-Closed, Open-Closed, Open-Open

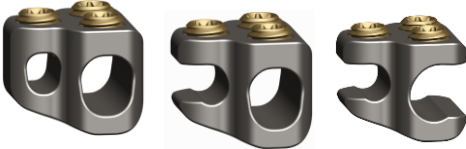

### Size Range

#### Sizes:

- 3.5mm x 3.5mm
- 3.5mm x 5.5mm

# DESIGN FEATURES

## OCCIPITAL PLATES

- Y-Shape and A-Shape Orientations
- 20-50mm Tulip Lateralization Range
  - Small: 25-35mm (Natural Titanium)
  - Medium: 32-42mm (Dark Blue)
  - Large: 40-50mm (Gold)
- $\pm 30^\circ$  of Tulip Rotation
- $\pm 15^\circ$  of Cephalad/Caudal Tulip Angulation



## OCCIPITAL SCREWS

- Diameters: 4.50mm and 5.25mm
- Lengths: 6-16mm (2mm increments)
  - 6mm: Natural Titanium
  - 8mm: Dark Blue
  - 10mm: Gold
  - 12mm: Green
  - 14mm: Purple
  - 16mm: Magenta
- Thread Pitch: 1 mm

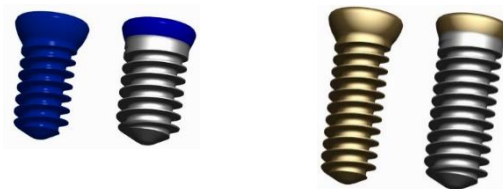

## OCCIPITAL RODS

- Material: Titanium and Cobalt Chrome
- Diameter: 3.5mm
- Pre-lordosed Angles:  $75^\circ$  and  $90^\circ$
- Length: Short - 50mm x 125mm

**NOTE:** Long, 125mm x 125mm available as Special Order





# DESIGN FEATURES

## TWO PLATE FOOTPRINTS WITH MIDLINE FIXATION

- Provide optimal fixation in the areas of greatest bone thickness



## CONTOUR ZONES

- Offer better bone plate interface for more stable fixation

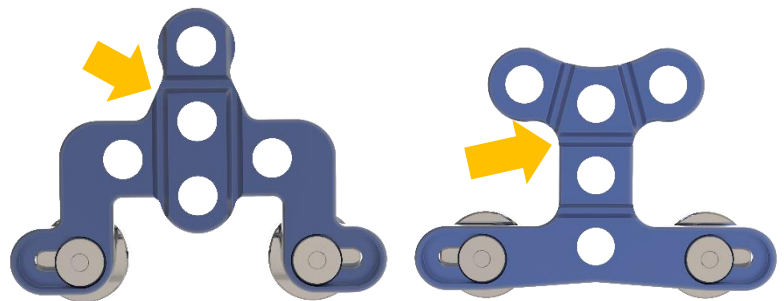

## TOTAL FREEDOM

- Tulip allows easier connection across the occipital cervical junction by minimizing rod contouring

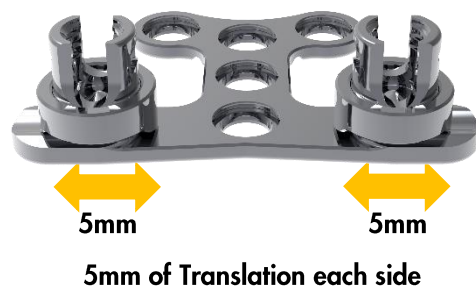
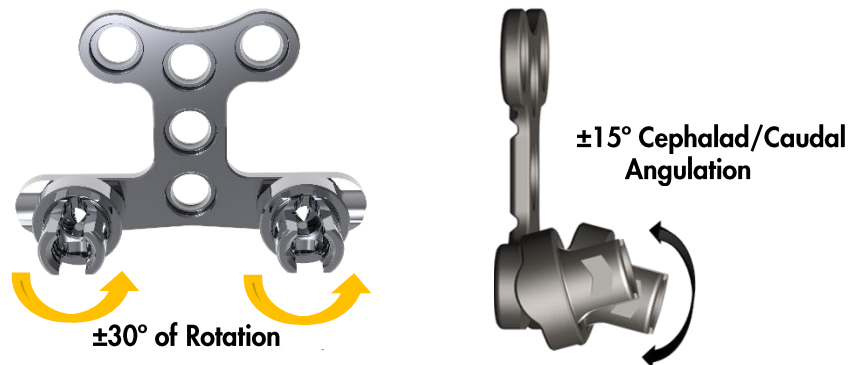



# DESIGN FEATURES



Polyaxial Screw  
Hexalobe – T15



PC Screw & Occipital Plate  
Locking Cap Hexalobe – T15



Occipital Plate Screw  
Hexalobe – T15



Domino Cap  
Hexalobe – T15



Cross Connector  
R-R Torque  
Hexalobe – T15



Cross Connector  
R-R Rod Lock  
Hexalobe – T15



Cross Connector  
Tulip – Tulip Torque  
Hexalobe – T15



Cross Connector  
Tulip - Tulip  
Hexalobe – T15



Cross Connector  
Tulip – Tulip  
Hex – 8mm or 5/16

# STANDARD IMPLANT CASE

TRAY NUMBER 55-BK-0101

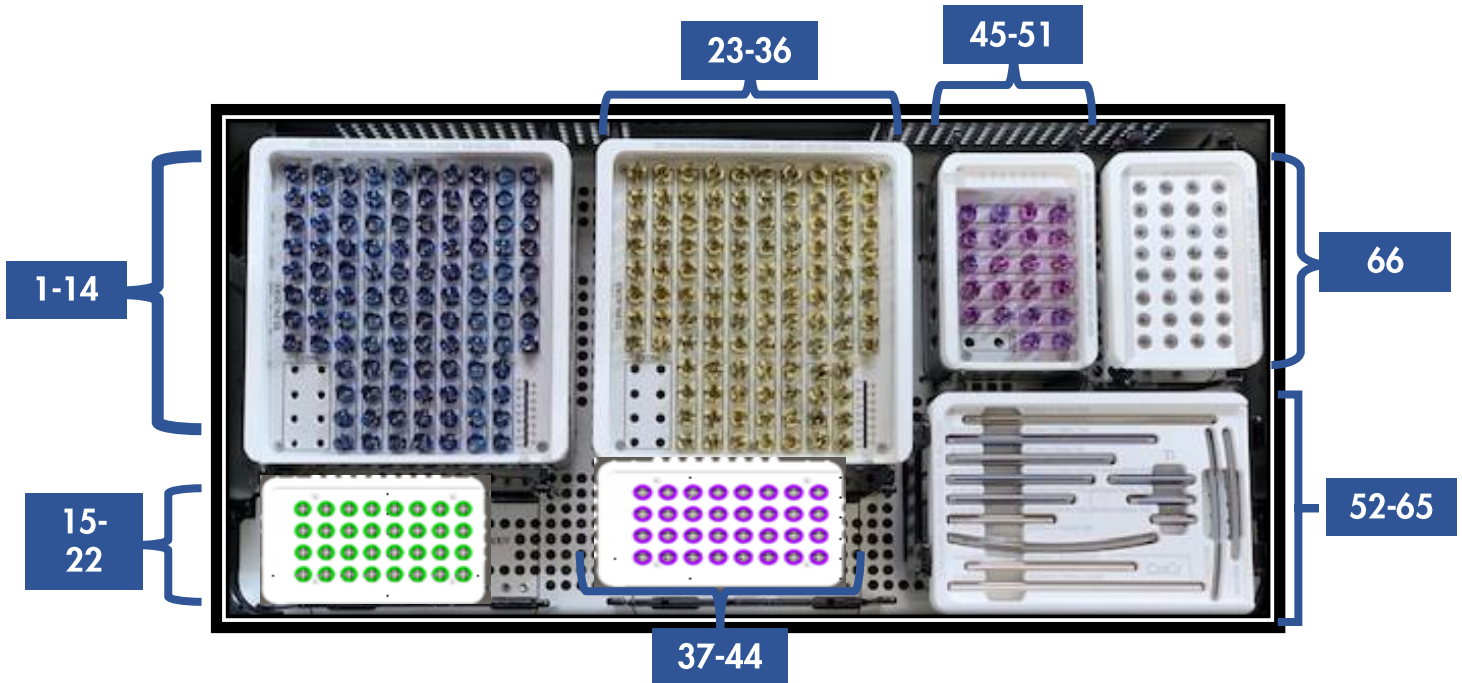

#	Part No.	Description	Qty.	#	Part No.	Description	Qty.
1.	55-PA-3508	Ø3.5 x 8mm Polyaxial Screw	8	32.	55-PA-4026	Ø4.0 x 26mm Polyaxial Screw	4
2.	55-PA-3510	Ø3.5 x 10mm Polyaxial Screw	8	33.	55-PA-4028	Ø4.0 x 28mm Polyaxial Screw	4
3.	55-PA-3512	Ø3.5 x 12mm Polyaxial Screw	12	34.	55-PA-4030	Ø4.0 x 30mm Polyaxial Screw	4
4.	55-PA-3514	Ø3.5 x 14mm Polyaxial Screw	12	35.	55-PA-4035	Ø4.0 x 35mm Polyaxial Screw	4
5.	55-PA-3516	Ø3.5 x 16mm Polyaxial Screw	12	36.	55-PA-4040	Ø4.0 x 40mm Polyaxial Screw	4
6.	55-PA-3518	Ø3.5 x 18mm Polyaxial Screw	12	37.	55-PB-4020	Ø4.0 x 20mm Smooth Shank Screw	4
7.	55-PA-3520	Ø3.5 x 20mm Polyaxial Screw	12	38.	55-PB-4022	Ø4.0 x 22mm Smooth Shank Screw	4
8.	55-PA-3522	Ø3.5 x 22mm Polyaxial Screw	8	39.	55-PB-4024	Ø4.0 x 24mm Smooth Shank Screw	4
9.	55-PA-3524	Ø3.5 x 24mm Polyaxial Screw	4	40.	55-PB-4026	Ø4.0 x 26mm Smooth Shank Screw	4
10.	55-PA-3526	Ø3.5 x 26mm Polyaxial Screw	4	41.	55-PB-4028	Ø4.0 x 28mm Smooth Shank Screw	4
11.	55-PA-3528	Ø3.5 x 28mm Polyaxial Screw	4	42.	55-PB-4030	Ø4.0 x 30mm Smooth Shank Screw	4
12.	55-PA-3530	Ø3.5 x 30mm Polyaxial Screw	4	43.	55-PB-4032	Ø4.0 x 32mm Smooth Shank Screw	4
13.	55-PA-3535	Ø3.5 x 35mm Polyaxial Screw	4	44.	55-PB-4034	Ø4.0 x 34mm Smooth Shank Screw	4
14.	55-PA-3540	Ø3.5 x 40mm Polyaxial Screw	4	45.	55-PA-4520	Ø4.5 x 20mm Polyaxial Screw	4
15.	55-PB-3520	Ø3.5 x 20mm Smooth Shank Screw	4	46.	55-PA-4525	Ø4.5 x 25mm Polyaxial Screw	4
16.	55-PB-3522	Ø3.5 x 22mm Smooth Shank Screw	4	47.	55-PA-4530	Ø4.5 x 30mm Polyaxial Screw	4
17.	55-PB-3524	Ø3.5 x 24mm Smooth Shank Screw	4	48.	55-PA-4535	Ø4.5 x 35mm Polyaxial Screw	4
18.	55-PB-3526	Ø3.5 x 26mm Smooth Shank Screw	4	49.	55-PA-4540	Ø4.5 x 40mm Polyaxial Screw	2
19.	55-PB-3528	Ø3.5 x 28mm Smooth Shank Screw	4	50.	55-PA-4545	Ø4.5 x 45mm Polyaxial Screw	2
20.	55-PB-3530	Ø3.5 x 30mm Smooth Shank Screw	4	51.	55-PA-4550	Ø4.5 x 50mm Polyaxial Screw	2
21.	55-PB-3532	Ø3.5 x 32mm Smooth Shank Screw	4	52.	55-ST-5120	Ø3.5 x 120mm Straight Rod Ti	3
22.	55-PB-3534	Ø3.5 x 34mm Smooth Shank Screw	4	53.	55-ST-5100	Ø3.5 x 100mm Straight Rod Ti	3
23.	55-PA-4008	Ø4.0 x 8mm Polyaxial Screw	8	54.	55-ST-5080	Ø3.5 x 80mm Straight Rod Ti	3
24.	55-PA-4010	Ø4.0 x 10mm Polyaxial Screw	8	55.	55-ST-5070	Ø3.5 x 70mm Straight Rod Ti	3
25.	55-PA-4012	Ø4.0 x 12mm Polyaxial Screw	12	56.	55-ST-5060	Ø3.5 x 60mm Straight Rod Ti	3
26.	55-PA-4014	Ø4.0 x 14mm Polyaxial Screw	12	57.	55-ST-5050	Ø3.5 x 50mm Straight Rod Ti	3
27.	55-PA-4016	Ø4.0 x 16mm Polyaxial Screw	12	58.	55-ST-5040	Ø3.5 x 40mm Straight Rod Ti	3
28.	55-PA-4018	Ø4.0 x 18mm Polyaxial Screw	12	59.	55-ST-5030	Ø3.5 x 30mm Straight Rod Ti	3
29.	55-PA-4020	Ø4.0 x 20mm Polyaxial Screw	12	60.	55-ST-5020	Ø3.5 x 20mm Straight Rod Ti	3
30.	55-PA-4022	Ø4.0 x 22mm Polyaxial Screw	8	61.	55-LT-5060	Ø3.5 x 60mm Lordotic Rod Ti	2
31.	55-PA-4024	Ø4.0 x 24mm Polyaxial Screw	4	62.	55-LT-5080	Ø3.5 x 80mm Lordotic Rod Ti	2
				63.	55-LT-5100	Ø3.5 x 100mm Lordotic Rod Ti	2
				64.	55-SC-5080	Ø3.5 x 80mm Straight Rod CoCr	3
				65.	55-SC-5120	Ø3.5 x 12mm Straight Rod CoCr	3
				66.	55-LS-0100	Standard Cap Screw	30

# ADD-ON IMPLANT CASE – TOP LEVEL

TRAY NUMBER 55-BK-0102

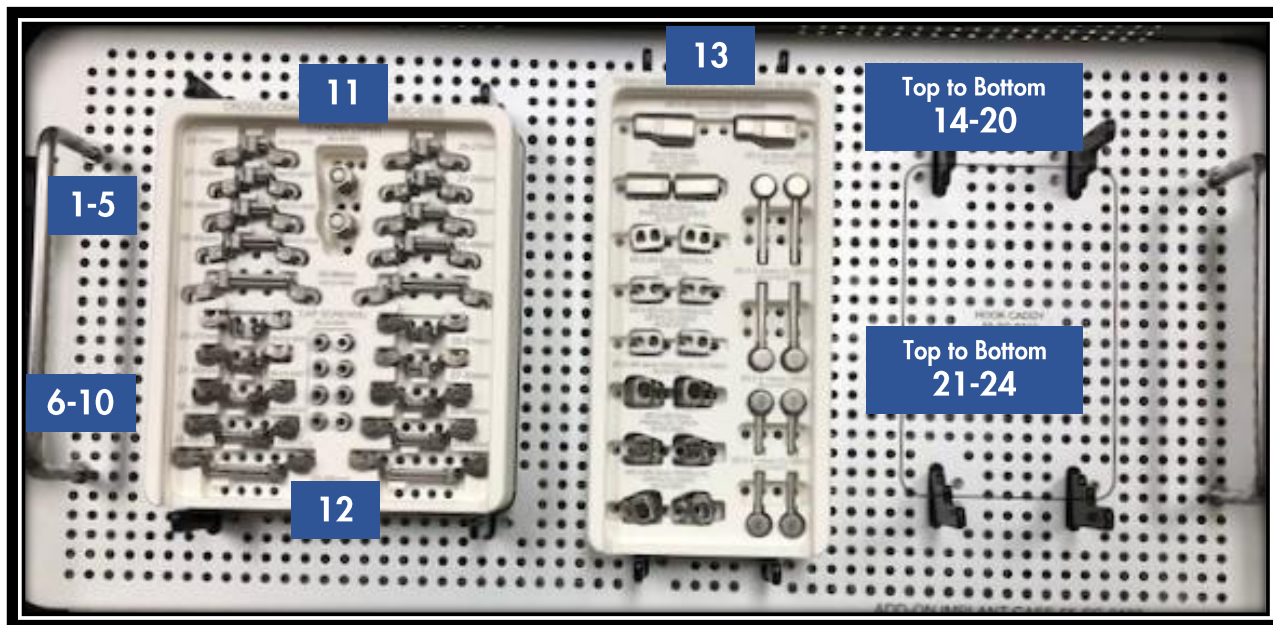

#	Part No.	Description	Qty.
1.	55-CC-0025	Rod-to-Rod Cross-Connector, 25-27mm	2
2.	55-CC-0027	Rod-to-Rod Cross-Connector, 27-30mm	2
3.	55-CC-0030	Rod-to-Rod Cross-Connector, 30-36mm	2
4.	55-CC-0035	Rod-to-Rod Cross-Connector, 35-46mm	2
5.	55-CC-0045	Rod-to-Rod Cross-Connector, 45-66mm	2
6.	55-CH-0025	Head-to-Head Cross-Connector, 25-27mm	2
7.	55-CH-0027	Head-to-Head Cross-Connector, 27-30mm	2
8.	55-CH-0030	Head-to-Head Cross-Connector, 30-36mm	2
9.	55-CH-0035	Head-to-Head Cross-Connector, 35-46mm	2
10.	55-CH-0045	Head-to-Head Cross-Connector, 45-66mm	2
11.	55-LS-0301	Head-to-Head Cross-Connector Locking Cap	8
12.	55-LS-0300	Head-to-Head Cross-Connector Cap Screw	8
13.	55-AA-0601	Ø3.5 – Ø5.5 Axial Domino, Closed	2
14.	55-AA-0101	Ø3.5 – Ø3.5 Axial Domino, Closed	2
15.	55-DA-0101	Ø3.5 – Ø3.5 Parallel Domino, Closed-Closed	2
16.	55-DA-0102	Ø3.5 – Ø3.5 Parallel Domino, Open-Open	2
17.	55-DA-0103	Ø3.5 – Ø3.5 Parallel Domino, Open-Closed	2
18.	55-DA-0601	Ø3.5 – Ø5.5 Parallel Domino, Closed-Closed	2
19.	55-DA-0602	Ø3.5 – Ø5.5 Parallel Domino, Open-Open	2
20.	55-DA-0603	Ø3.5 – Ø5.5 Parallel Domino, Open-Closed	2
21.	55-LO-0125	Ø3.5 x 25mm Lateral Offset, Open	2
22.	55-LO-0025	Ø3.5 x 25mm Lateral Offset, Closed	2
23.	55-LO-0115	Ø3.5 x 15mm Lateral Offset, Open	2
24.	55-LO-0015	Ø3.5 x 15mm Lateral Offset, Closed	2

# ADD-ON IMPLANT CASE – BOTTOM LEVEL

TRAY NUMBER 55-BK-0102

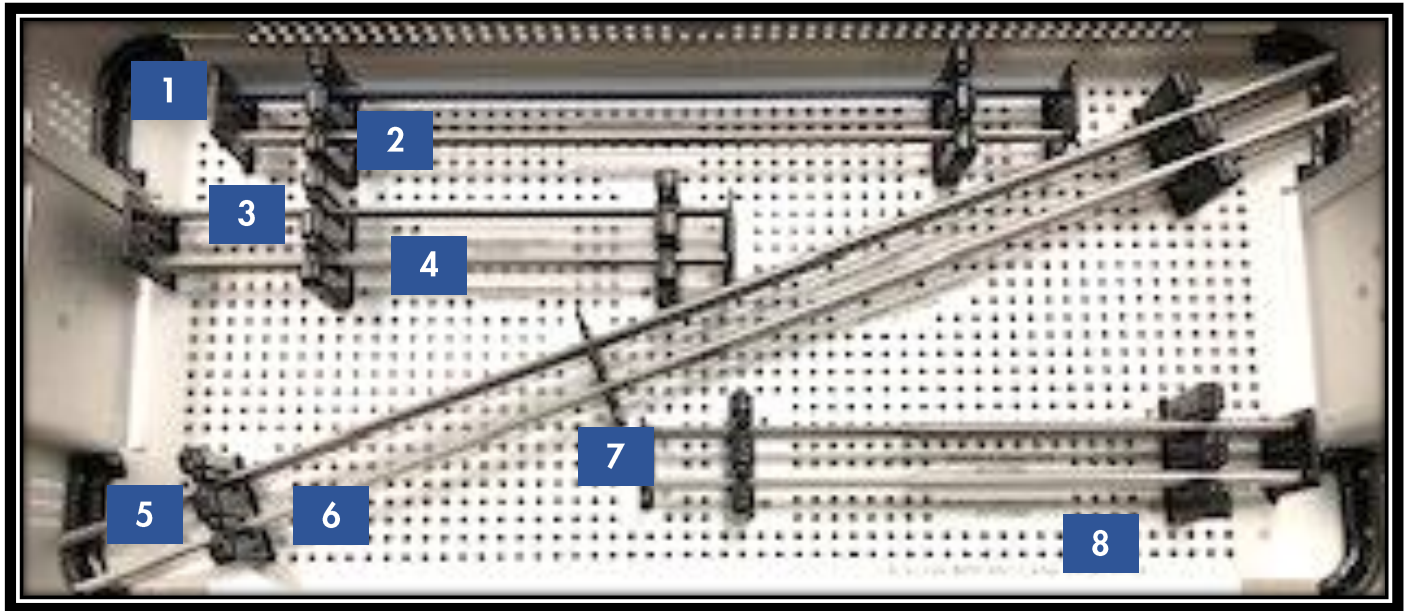

#	Part No.	Description	Qty
1.	55-ST-5350	Ø3.5 x 350mm Straight Rod, Ti	3
2.	55-SC-5350	Ø3.5 x 350mm Straight Rod, CoCr	3
3.	55-ST-5240	Ø3.5 x 240mm Straight Rod, Ti	3
4.	55-SC-5240	Ø3.5 x 240mm Straight Rod, CoCr	3
5.	55-TT-5508	Ø3.5 – Ø5.5 x 550mm Transition Rod, Ti	3
6.	55-TC-5508	Ø3.5 – Ø5.5 x 550mm Transition Rod, CoCr	3
7.	55-TT-5502	Ø3.5 – Ø5.5 x 250mm Transition Rod, Ti	3
8.	55-TC-5502	Ø3.5 – Ø5.5 x 250mm Transition Rod, CoCr	3



# STANDARD INSTRUMENT CASE – TOP LEVEL

TRAY NUMBER 55-BK-0201

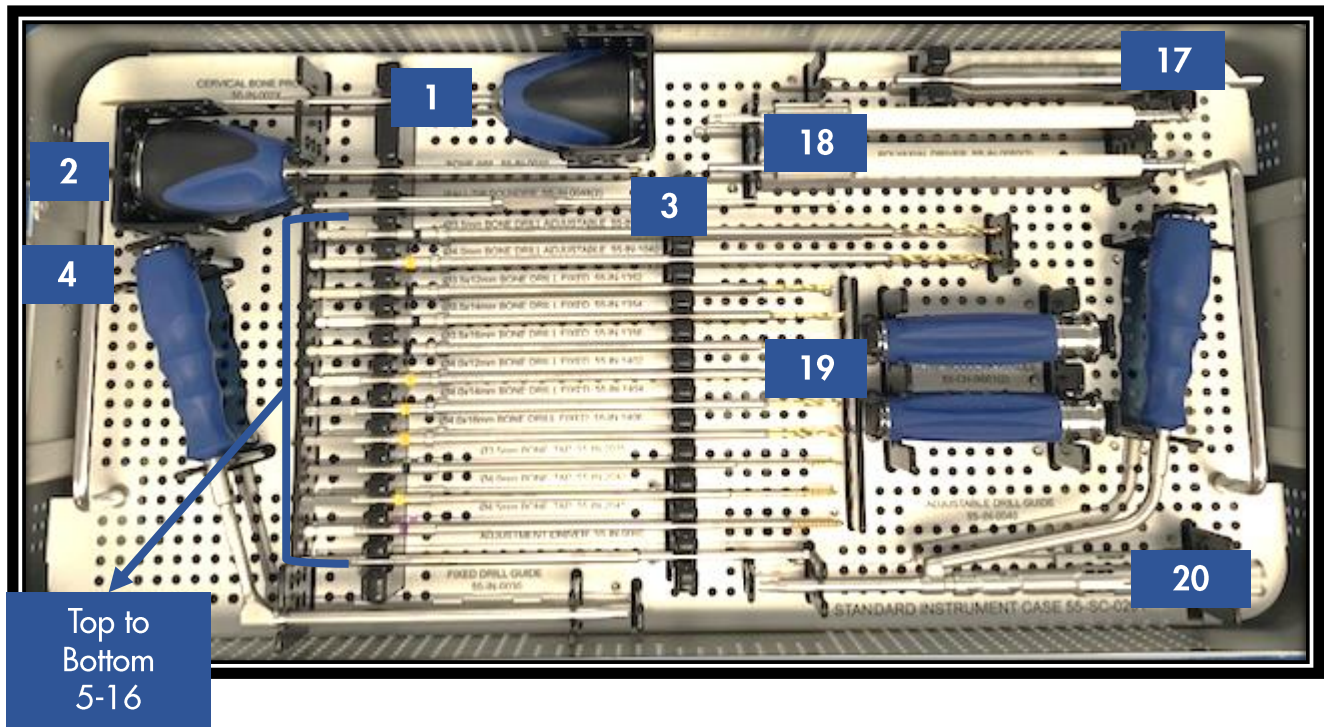

#	Part No.	Description	Qty
1.	55-IN-0020	Cervical Bone Probe	1
2.	55-IN-0010	Bone Awl	1
3.	55-IN-0048	Ball-Tip Sounder/Feeler Probe	2
4.	55-IN-0030	Fixed Drill Guide	1
5.	55-IN-1035	Ø3.5mm Bone Drill – Adjustable	1
6.	55-IN-1040	Ø4.0mm Bone Drill – Adjustable	1
7.	55-IN-1352	Ø3.5 x 12mm Bone Drill – Fixed	1
8.	55-IN-1354	Ø3.5 x 14mm Bone Drill – Fixed	1
9.	55-IN-1356	Ø3.5 x 16mm Bone Drill – Fixed	1
10.	55-IN-1402	Ø4.0 x 12mm Bone Drill – Fixed	1
11.	55-IN-1404	Ø4.0 x 14mm Bone Drill – Fixed	1
12.	55-IN-1406	Ø4.0 x 16mm Bone Drill – Fixed	1
13.	55-IN-2035	Ø3.5mm Bone Tap	1
14.	55-IN-2040	Ø4.0mm Bone Tap	1
15.	55-IN-2045	Ø4.5mm Bone Tap	1
16.	55-IN-0060	Adjustment Driver	1
17.	55-IN-0049	Depth Gauge	1
18.	55-IN-0050	Polyaxial Driver	2
19.	55-CH-0001	Inline Modular Handle, Spin-Cap	2
20.	55-IN-0040	Adjustable Drill Guide	1

# STANDARD INSTRUMENT CASE – BOTTOM LEVEL

TRAY NUMBER 55-BK-0201

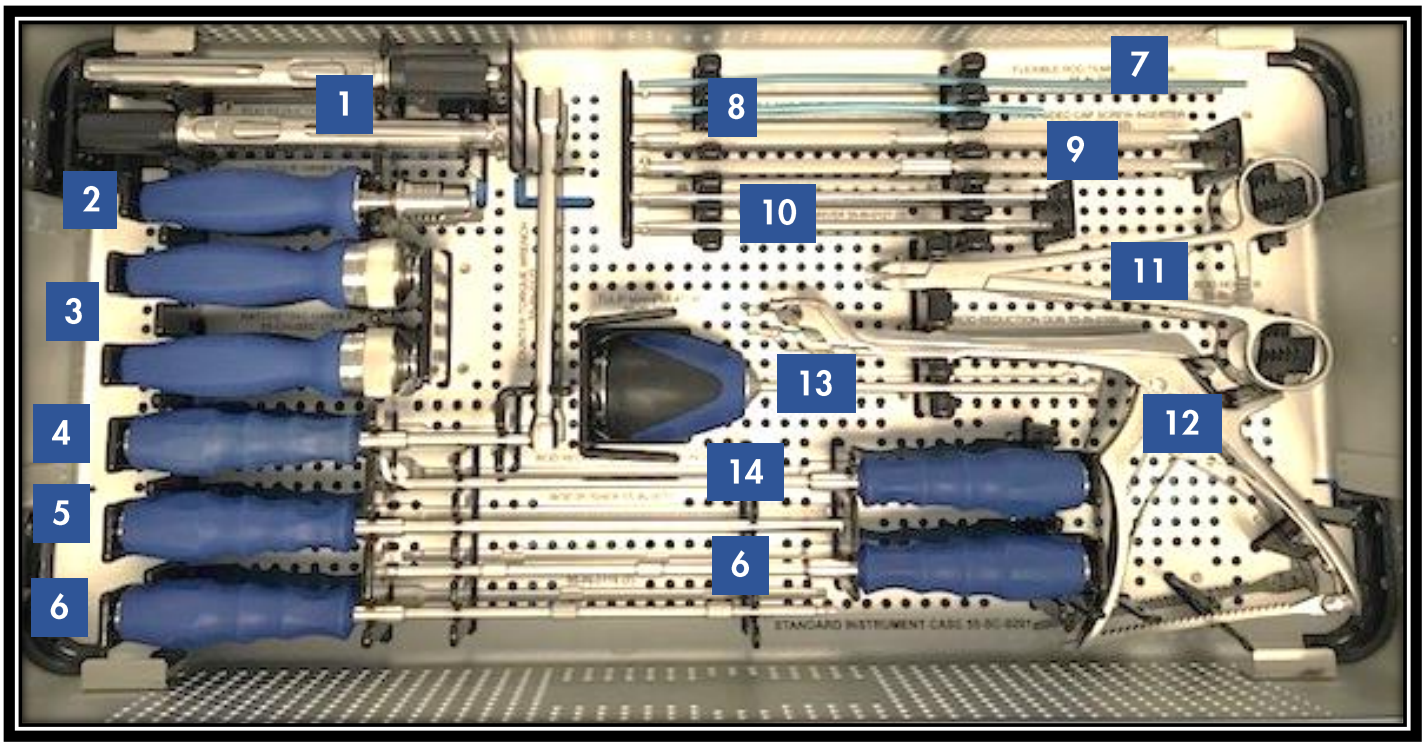

#	Part No.	Description	Qty
1.	55-IN-0114	Rod Reduction Tower	2
2.	55-CH-0003	Torque Limiting Handle	1
3.	55-CH-0002	Inline Modular Handle; Ratchet	2
4.	55-IN-0122	Counter Torque Wrench	1
5.	55-IN-0071	Rod Pusher	1
6.	55-IN-0119	Single Sided Cap Screw Retention Driver	2
7.	55-IN-0067	Flexible Rod Template – 250mm	1
8.	55-IN-0066	Flexible Rod Template – 150mm	1
9.	55-IN-0118	Dual-Sided Cap Screw Inserter	2
10.	55-IN-0121	Torque Driver	2
11.	55-IN-0068	Rod Holder	1
12.	55-IN-0100	Rod Reduction Gun	1
13.	55-IN-0061	Tulip Manipulator	1
14.	55-IN-0110	Rod Reduction Rocker	1

# ADD-ON INSTRUMENT CASE – TOP LEVEL

TRAY NUMBER 55-BK-0203

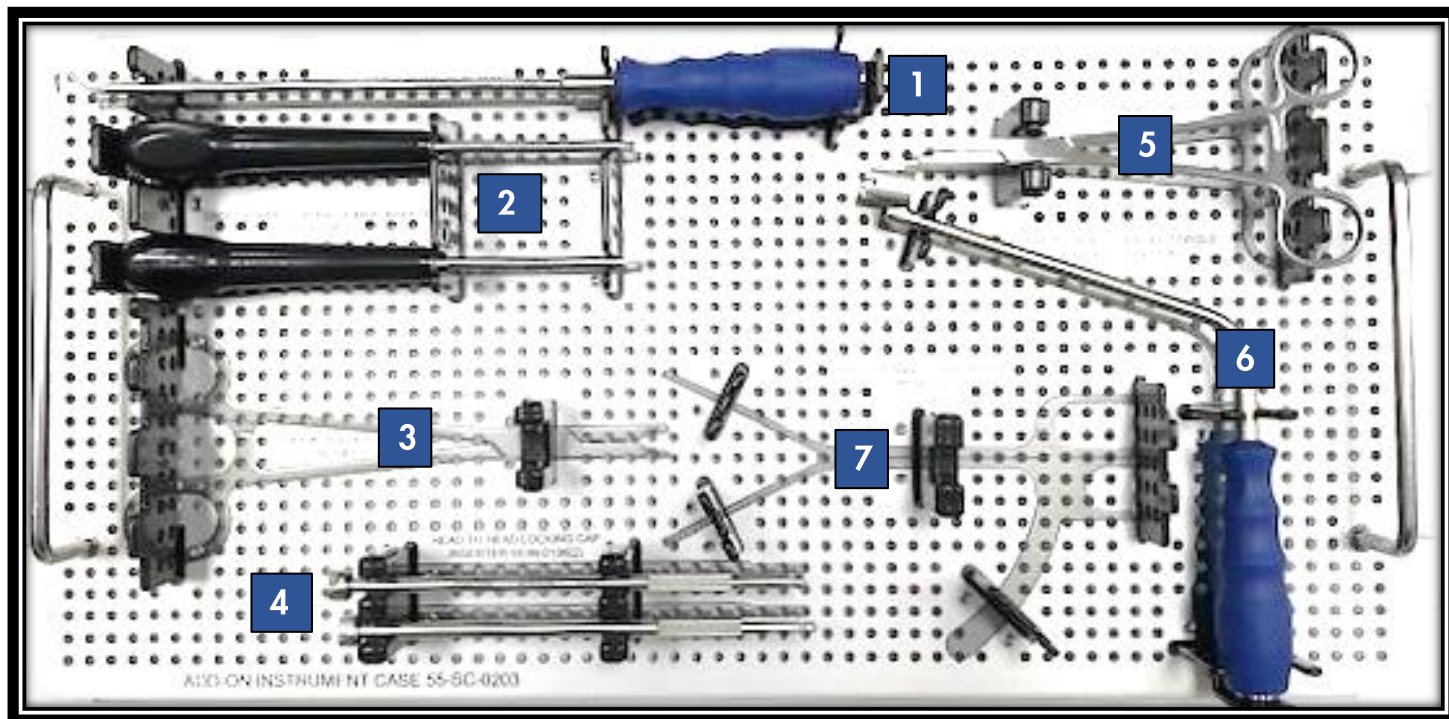

#	Part No.	Description	Qty
1.	55-IN-0140	Laminar Elevator	1
2.	55-IN-0138	Cross-Connector and Domino Inserter	2
3.	55-IN-0063	Hook Holder	1
4.	55-IN-0136	Head-to-Head Locking Cap Inserter	2
5.	55-IN-0125	Cross-Connector Inserter	1
6.	55-IN-0126	Head-to-Head Counter Torque Wrench	1
7.	55-IN-0130	Cross-Connector Caliper	1



# ADD-ON INSTRUMENT CASE – BOTTOM LEVEL

TRAY NUMBER 55-BK-0203

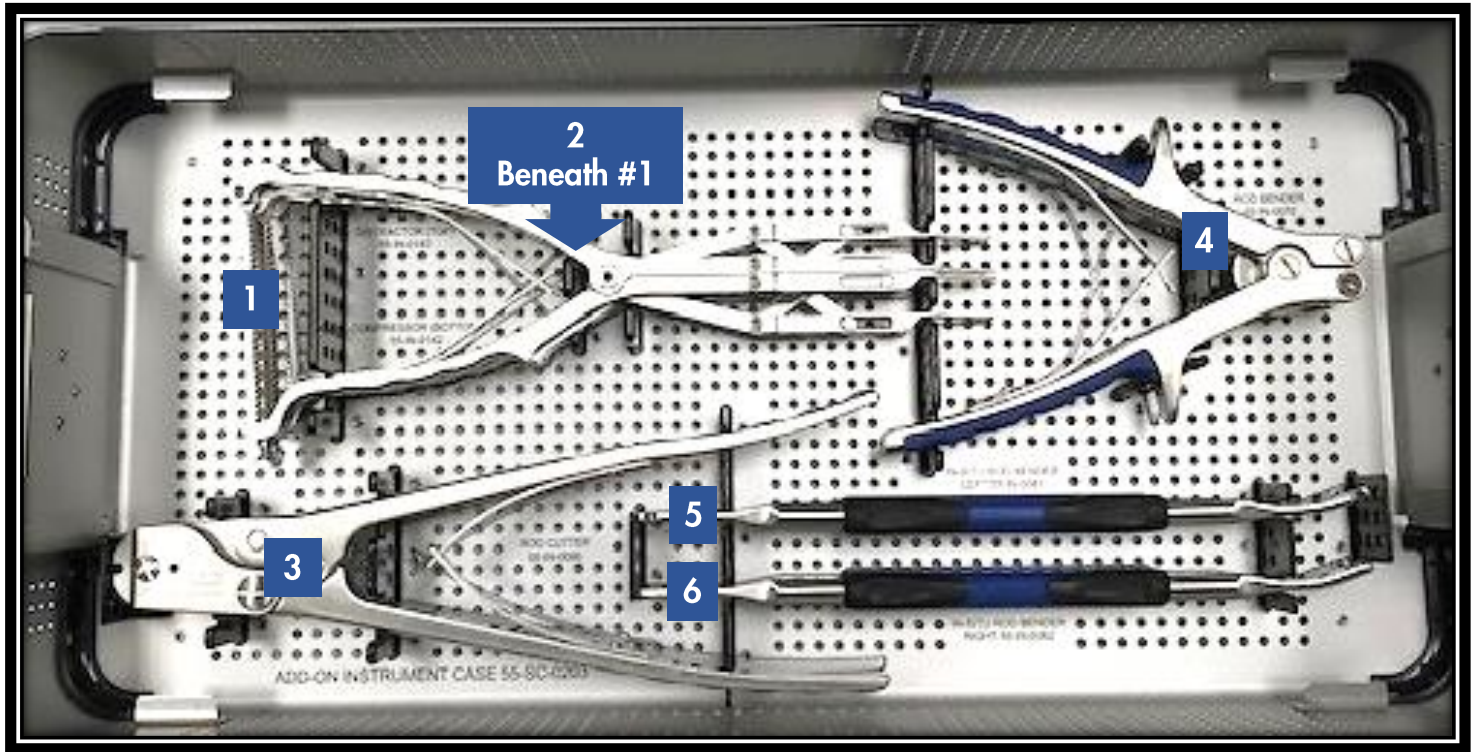

#	Part No.	Description	Qty.
1.	55-IN-0143	Distractor	1
2.	55-IN-0142	Compressor	1
3.	55-IN-0090	Rod Cutter	1
4.	55-IN-0070	Standard Rod Bender	1
5.	55-IN-0081	<i>In-situ</i> Rod Bender; Left	1
6.	55-IN-0082	<i>In-situ</i> Rod Bender; Right	1

# OCCIPTAL IMPLANT CASE

TRAY NUMBER 55-BK-0103

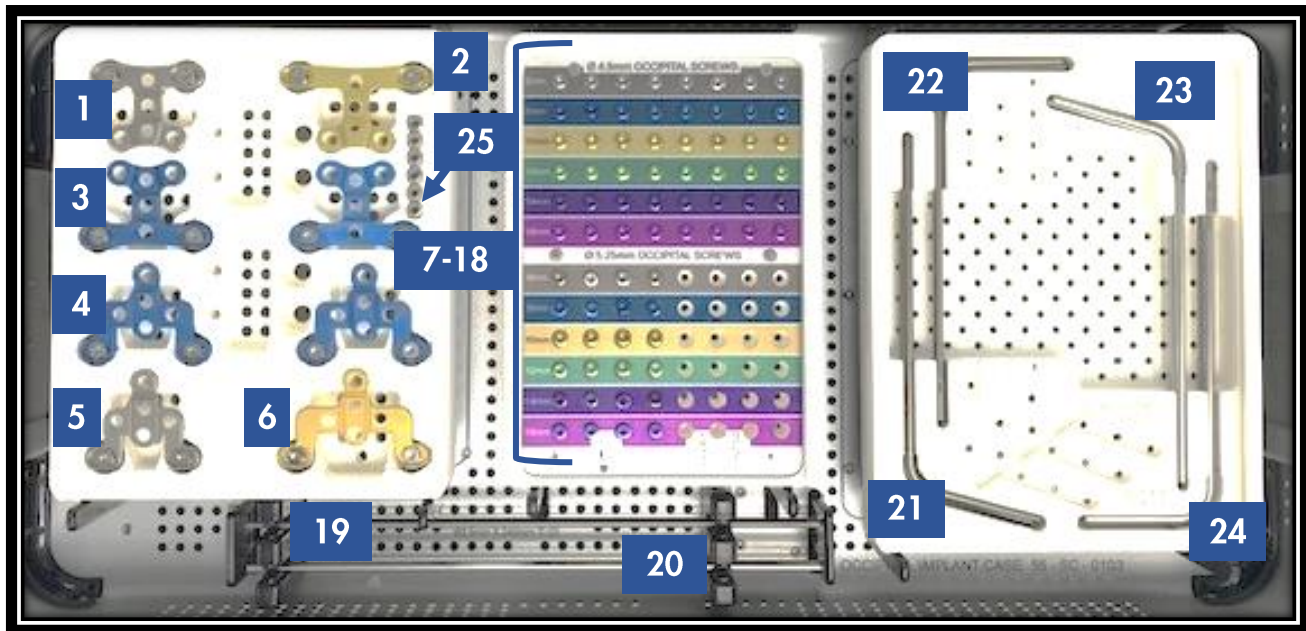

#	Part No.	Description	Qty
1.	55-OA-0101	Y-Shape, Occipital Plate, 25-35mm	1
2.	55-OA-0103	Y-Shape, Occipital Plate, 240-50mm	1
3.	55-OA-0102	Y-Shape, Occipital Plate, 32-42mm	2
4.	55-OA-0202	A-Shape, Occipital Plate, 32-42mm	2
5.	55-OA-0201	A-Shape, Occipital Plate, 25-35mm	1
6.	55-OA-0203	A-Shape, Occipital Plate, 40-50mm	1
7.	55-OS-4506	Ø4.50 x 6mm Occipital Screw	8
8.	55-OS-4508	Ø4.50 x 8mm Occipital Screw	8
9.	55-OS-4510	Ø4.50 x 10mm Occipital Screw	8
10.	55-OS-4512	Ø4.50 x 12mm Occipital Screw	8
11.	55-OS-4514	Ø4.50 x 14mm Occipital Screw	8
12.	55-OS-4516	Ø4.50 x 16mm Occipital Screw	8
13.	55-OS-5206	Ø5.25 x 6mm Occipital Screw	4
14.	55-OS-5208	Ø5.25 x 8mm Occipital Screw	4
15.	55-OS-5210	Ø5.25 x 10mm Occipital Screw	4
16.	55-OS-5212	Ø5.25 x 12mm Occipital Screw	4
17.	55-OS-5214	Ø5.25 x 14mm Occipital Screw	4
18.	55-OS-5216	Ø5.25 x 16mm Occipital Screw	4
19.	55-ST-5240	Ø3.50 x 240mm Straight Rod, Titanium	2
20.	55-SC-5240	Ø3.50 x 240mm Straight Rod, CoCr	2
21.	55-OR-0503	Ø3.50 X 75° Pre-lordosed Occipital Rod, Short, Titanium	3
22.	55-OR-0500	Ø3.50 X 90° Pre-lordosed Occipital Rod, Short, Titanium	3
23.	55-OR-0603	Ø3.50 X 75° Pre-lordosed Occipital Rod, Short, CoCr	3
24.	55-OR-0600	Ø3.50 X 90° Pre-lordosed Occipital Rod, Short, CoCr	3
25.	55-LS-0100	Standard Cap Screw	6

# OCCIPTAL INSTRUMENT CASE – TOP LEVEL

TRAY NUMBER 55-BK-0202

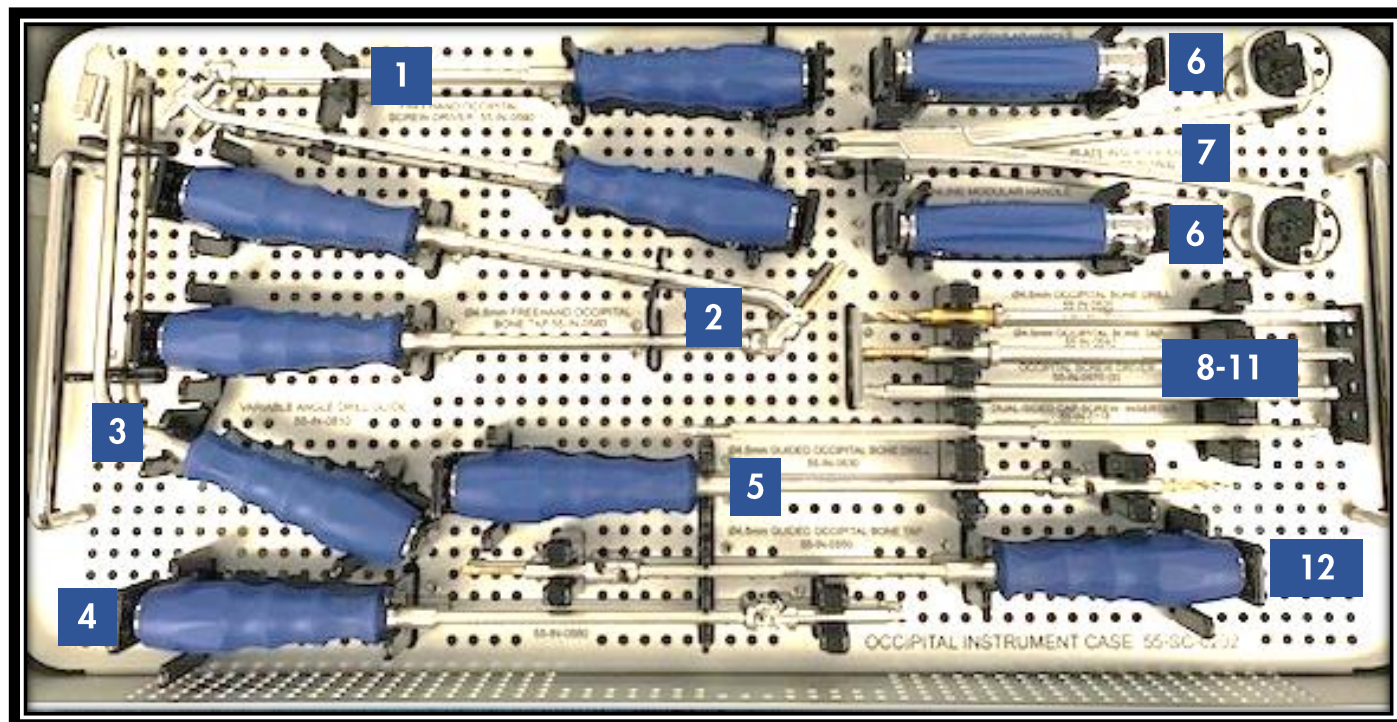

#	Part No.	Description	Qty.
1.	55-IN-0590	Occipital Screw Driver, Freehand	1
2.	55-IN-0560	Ø4.5mm Occipital Bone Tap, Freehand	1
3.	55-IN-0510	Variable Angle Guide	1
4.	55-IN-0580	Occipital Screw Driver, Angled	1
5.	55-IN-0530	Ø4.5mm Occipital Bone Drill, Angled	1
6.	55-CH-0001	Inline Modular Handle, Spin-Cap	2
7.	55-IN-0500	All-in-One Plate Inserter and Guide	1
8.	55-IN-0520	Ø4.5mm Occipital Bone Drill, Straight	1
9.	55-IN-0540	Ø4.5mm Occipital Bone Tap, Straight	1
10.	55-IN-0570	Occipital Screw Driver, Straight	2
11.	55-IN-0118	Dual-Sided Cap Screw Inserter	1
12.	55-IN-0550	Ø4.5mm Occipital Bone Tap, Guided	1



# OCCIPTAL INSTRUMENT CASE – BOTTOM LEVEL

TRAY NUMBER 55-BK-0202

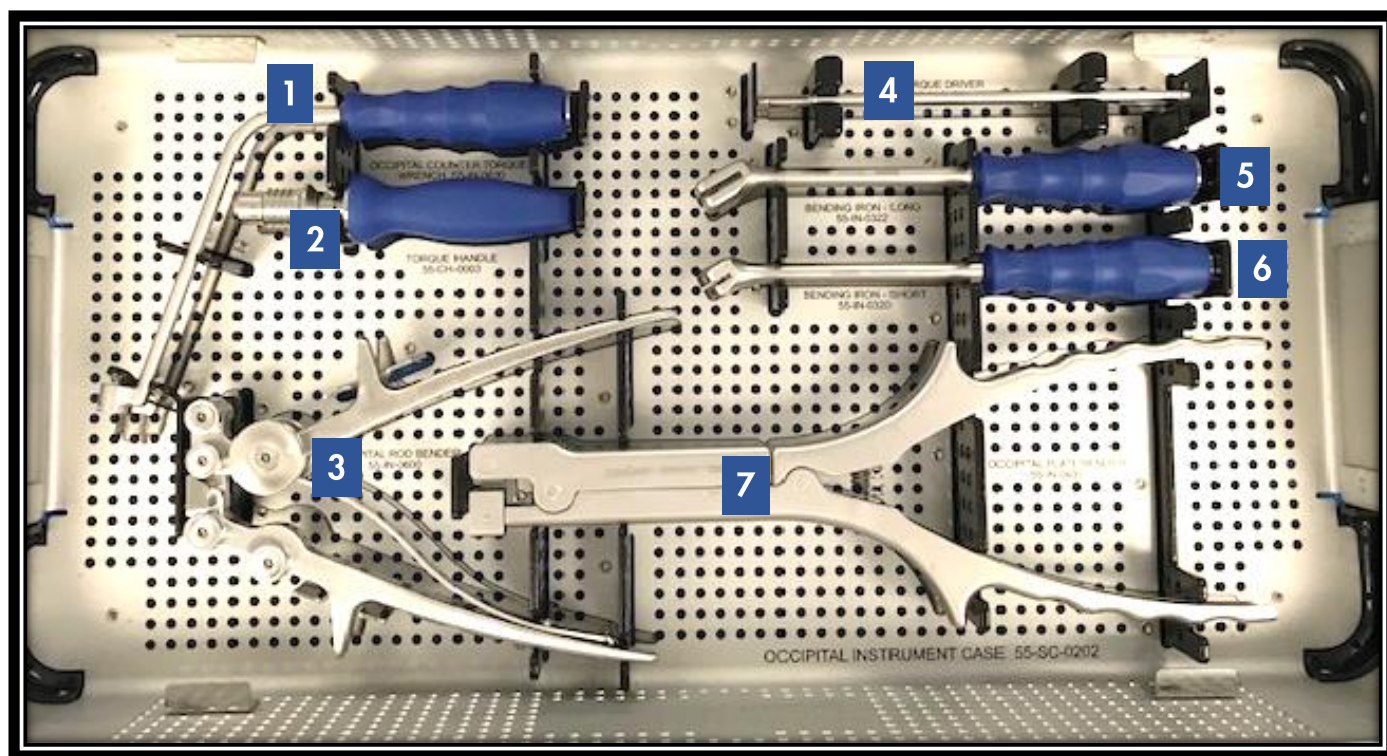

#	Part No.	Description	Qty
1.	55-IN-0630	Occipital Plate Counter Torque Wrench	1
2.	55-CH-0003	Torque Handle	1
3.	55-IN-0600	Occipital Rod Bender, Hyperlordotic	1
4.	55-IN-0121	Torque Driver	1
5.	55-IN-0322	Occipital Plate Bending Iron, Long	1
6.	55-IN-0320	Occipital Plate Bending Iron, Short	1
7.	55-IN-0400	Occipital Plate Bender	1

# SPECIAL ORDER IMPLANTS & INSTRUMENTS

## NOT AVAILABLE IN STANDARD KITS

### Reform POCT System Implants – Special Order

Part No.	Description
55-TT-5510	Ø3.5-Ø5.5 x 650mm Transition Rod, Titanium
55-TC-5510	Ø3.5-Ø5.5 x 650mm Transition Rod, CoCr
55-PA-4514	Ø4.5 x 14mm Polyaxial Screw
55-PA-4516	Ø4.5 x 16mm Polyaxial Screw
55-PA-4518	Ø4.5 x 18mm Polyaxial Screw
55-PB-3536	Ø3.5 x 36mm Smooth Shank Screw
55-PB-3538	Ø3.5 x 38mm Smooth Shank Screw
55-PB-3540	Ø3.5 x 40mm Smooth Shank Screw
55-PB-4036	Ø4.0 x 36mm Smooth Shank Screw
55-PB-4038	Ø4.0 x 38mm Smooth Shank Screw
55-PB-4040	Ø4.0 x 40mm Smooth Shank Screw
55-AA-0102	Ø3.5-Ø3.5 Axial Domino, Open-Open
55-AA-0103	Ø3.5-Ø3.5 Axial Domino, Open-Closed
55-AA-0602	Ø3.5-Ø5.5 Axial Domino, Open-Open
55-AA-0603	Ø3.5-Ø5.5 Axial Domino, Open-Closed
55-AA-0604	Ø3.5-Ø5.5 Axial Domino, Closed-Open
55-DA-0604	Ø3.5-Ø5.5 Parallel Domino, Closed-Open
55-OA-0301	Bi-lateral Occipital Plate, Left
55-OA-0302	Bi-lateral Occipital Plate, Right
55-OR-0510	Ø3.5 x 90° Pre-lordosed Occipital Rod, Long, Titanium
55-OR-0513	Ø3.5 x 75° Pre-lordosed Occipital Rod, Long, Titanium
55-OR-0610	Ø3.5 x 90° Pre-lordosed Occipital Rod, Long, CoCr
55-OR-0613	Ø3.5 x 75° Pre-lordosed Occipital Rod, Long, CoCr
55-OR-0200	Ø3.5 Adjustable Occipital Rod, Titanium

### Reform POCT System Instruments – Special Order

Part No.	Description
55-CH-0004	Inline Modular Torque Indicating Handle; Cap Screw
55-CH-0005	T-Handle Modular Torque Limiting Handle; Cap Screw
55-IN-0021	Ø4.5mm Straight Bone Probe
55-IN-0022	Ø4.0mm Straight Bone Probe
55-IN-0023	Ø4.5mm Duckbill Bone Probe
55-IN-0024	Ø4.0mm Duckbill Bone Probe
55-IN-0713	Inline Counter Torque Wrench
55-IN-0721	Ø3.5mm Coronal Rod Bender, Left
55-IN-0722	Ø3.5mm Coronal Rod Bender, Right
55-IN-0730	Self-retaining Bone Screw Driver

# SURGICAL TECHNIQUE

## 1

### PREOPERATIVE PLANNING

The appropriate imaging techniques to outline the patient's osseous anatomy should be utilized to determine the proper size and type of hardware to be implanted.

The patient is placed in the prone position with the head and neck held securely in optimal alignment. A standard midline incision is performed at the appropriate levels.

## 2

### POLYAXIAL SCREW PLACEMENT

Following exposure, locate the desired entry point and screw trajectory and perforate the cortex with the Bone Awl (55-IN-0010) (Figure 1). This helps to prevent displacement of the drill bit during initial insertion.

A Fixed Drill Guide (55-IN-0030) is available with Bone Drills available in 12, 14 & 16mm lengths. The drill bits are undersized by 1mm. Select the appropriate length Bone Drill and Drill Guide. Align the distal tip of either the Fixed Drill Guide to the perforation created by the Bone Awl and advance the Bone Drill to the desired depth (Figure 2).

The Adjustable Drill Guide (55-IN-0040) is also available and allows for a single Adjustable Drill Bit (55-IN-1035 or 55-IN-1040) to be used. Set the Adjustable Drill Guide to the desired depth by sliding back the sleeve of the guide. Adjust the position by rotating the sleeve so that the mark on the guide indicates the required depth. Release the sleeve to lock the Adjustable Drill Guide at the desired depth. Align the distal tip to the perforation created by the Bone Awl and advance the Bone Drill to the desired depth (Figure 2A).

**NOTE: The Adjustable Drill Bit should not be used with the Fixed Drill Guides**



Figure 1



Figure 2

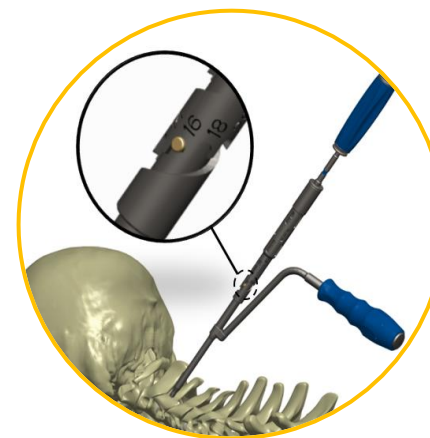

Figure 2A

# SURGICAL TECHNIQUE

## 2

## POLYAXIAL SCREW PLACEMENT (Cont.)

Verify the integrity of the pathway with the Ball-tip Sounder (55-IN-0048) (Figure 3) and verify the depth prepared with the Depth Gauge (55-IN-0049) (Figure 4).

Select the appropriately sized Bone Tap (55-IN-2035, 55-IN-2040, or 55-IN-2045) and align the Tap with the Drill hole and prepare to the desired length (Figure 5). Length markings are indicated along the shaft of each Bone Tap (Figure 6).

Assemble the preferred size and length Polyaxial Screw to the Polyaxial Screw Driver (55-IN-0050) by placing the hexalobular fitting into the head of the screw and threading the outer sleeve of the driver into the screw tulip. Be certain that the driver is fully seated in the screw head (Figure 7).

Advance the polyaxial screw to the desired depth following the path made by the drill and/or tap (Figure 7a).

Once seated, remove the Polyaxial Screw Driver from the implanted screw by rotating the locking sleeve counter-clockwise.

### (OPTIONAL)

The implanted Polyaxial Screw depth may be easily adjusted by utilizing the Adjustment Driver (55-IN-0060).

Orient the Tulip Head of the Polyaxial Screw to the desired angulation by utilizing the Tulip Manipulator (55-IN-0061) (Figure 8).

Repeat steps to insert Polyaxial Screws to each desired location.



Figure 3



Figure 4



Figure 5



Figure 6



Figure 7



Figure 7a

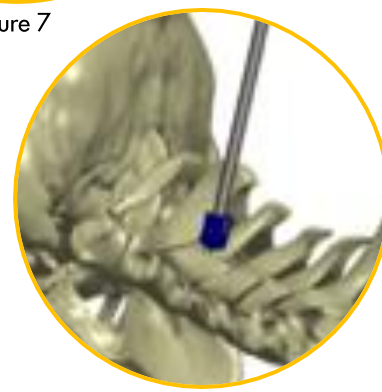

Figure 8



# SURGICAL TECHNIQUE

## 3

## ROD PLACEMENT

Select an appropriately sized Stabilization Rod and insert the Rod with the Rod Holder (55-IN-0068) so that it fits securely within the Tulip Head of the implanted Polyaxial Screws (Figure 9).

### (OPTIONAL)

The Flexible Rod Template (55-IN-0066, 55-IN-0067) may be used as a guide to aid in creating the desired Rod contour.

### (OPTIONAL)

The Stabilization Rods are available in various lengths, however, the Rod Cutter (55-IN-0090) may be utilized to shorten a Rod to the desired length.

### (OPTIONAL)

The Standard Rod Bender (55-IN-0070) may be utilized if Rod contouring is desired.

### (OPTIONAL)

Lateral Offsets (55-LO-XXXX) and Dominoes (55-DA-XXXX, 55-AA-XXXX) may be utilized to assist with matching the construct to accommodate patient anatomy.

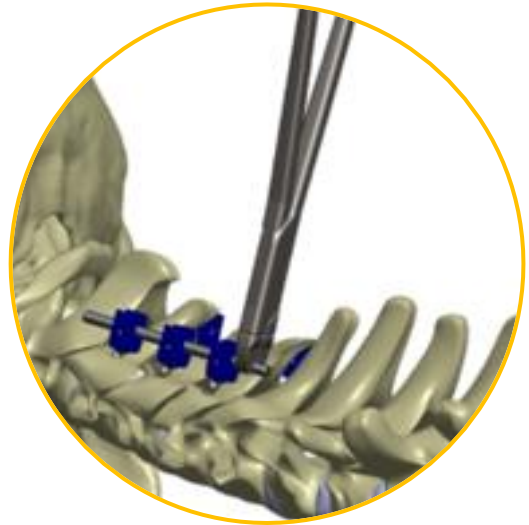

Figure 9

# SURGICAL TECHNIQUE

## 4

## ROD REDUCTION

The Rod Pusher (55-IN-0071) (Figure 10a), Rod Reduction Gun (55-IN-0100) (Figure 10b), Rod Tower Reducer (55-IN-0114) (Figure 10c), and Rod Reduction Rocker (55-IN-0110) (Figure 10d) may be used to assist with assembly of the Rod to the Polyaxial Screw Tulip.

Insert a Cap Screw (55-LS-0100) utilizing the Single Sided Cap Screw Retention Driver (55-IN-0119) (Figure 11) or Dual Sided Cap Screw Inserter (55-IN-0118) (Figure 12) and preliminarily tighten by hand.

### (OPTIONAL)

The Single Sided Cap Screw inserter may be utilized in conjunction with the Counter Torque Wrench (55-IN-0122) to ease alignment of the Cap Screw.

Repeat for each implanted Polyaxial Screw.



Figure 10a



Figure 10b



Figure 10c

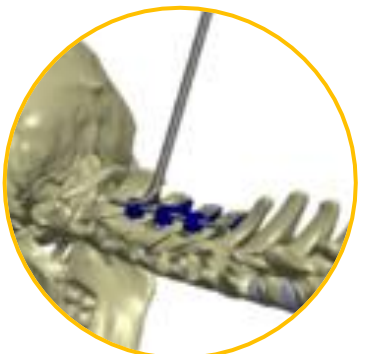

Figure 10d



Figure 11



Figure 12

# SURGICAL TECHNIQUE

## 5

### FINAL TIGHTENING

Final tighten each Cap Screw by assembling the Counter Torque Wrench (55-IN-0122) to the desired Polyaxial Screw and inserting the Torque Driver (55-IN-0121) through the Torque Wrench Barrel. Ensure the Driver is properly seated within the Cap Screw and rotate clockwise until the torque limit of the Modular Torque Handle (55-CH-0003) is reached (27in-lbs  $\pm$  10%) (Figure 13).

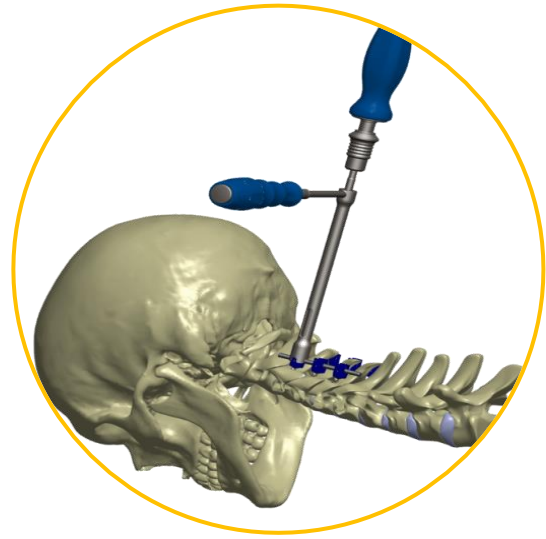

Figure 13

## 6

### HOOK PLACEMENT

1. Select the appropriate size and orientation of the Hook (55-TH-XXXX) to correspond to patient anatomy.
2. Assemble the Hook to the Hook Holder (55-IN-0063) and place the Hook under the superior or inferior lamina (Figure 14). The Hook may be placed in either a cranial or caudal position.
3. Repeat Steps 1-2 of the Hook Technique to insert Hooks at each desired location.
4. Repeat Step 1 of the Rod Placement Technique through Step 1 of the Final Tightening Technique to finalize the Hook construct.



Figure 14

# SURGICAL TECHNIQUE

## 7

## CROSS-CONNECTOR ATTACHMENT

Cross-connectors (55-CC-00XX, 55-CH-00XX) may be added to a construct if desired.

The Cross-connector Calipers (55-IN-0130) may be used to determine the proper length of Cross-connector.

Select the appropriately sized Cross-connector and insert utilizing the Cross-connector Inserter (55-IN-0125) (Figure 15).

The Rod-to-Rod Cross-connectors may be implanted utilizing the Cross-connector and Domino Inserter (55-IN-0138) and/or the Cross-connector Inserter.

### ROD-TO-ROD CROSS-CONNECTOR ASSEMBLY

Once each hook end of the Cross-connector is fully seated on the rod, rotate the Cross-connector and Domino Inserter (55-IN-0138) 90° clockwise to fully engage the Cross-connector cam to the Rod (Figure 16).

Once the desired span length and Cross-connector orientation is determined, final tighten the midline cap screw by rotating the Torque Driver (55-IN-0121) until the torque limit of the Modular Torque Handle (55-CH-0003) is reached (27in-lbs  $\pm$  10%).



Figure 15



Figure 16

# SURGICAL TECHNIQUE

## 7

## CROSS-CONNECTOR ATTACHMENT (Cont.)

### HEAD-TO-HEAD CROSS-CONNECTOR ASSEMBLY

Once each hook end of the Cross-Connector is fully seated on the rod, insert the Head-to-Head Cap Screw (55-LS-0300) through the appropriate Polyaxial Screw Tulip.

Final tighten each Head-to-Head Cap Screw by assembling the Head-to-Head Counter Torque Wrench (55-IN-0126) to the desired Polyaxial Screw and inserting the Torque Driver (55-IN-0121) through the Torque Wrench Barrel.

Ensure the Driver is properly seated within the Cap Screw and rotate clock-wise until the torque limit of the Modular Torque Handle (55-CH-0003) is reached (27in-lbs  $\pm$  10%) (Figure 17).

Insert the Head-to-Head Locking Cap with the Head-to-Head Locking Cap Inserter (55-IN-0136) over each Head-to-Head Cap Screw and preliminarily tighten.

Final tighten each Head-to-Head Locking Cap by assembling the Head-to-Head Counter Torque Wrench (55-IN-0126) to the desired Polyaxial Screw and inserting the Head-to-Head Locking Cap Inserter (55-IN-0136) assembled with the Modular Torque Handle (55-CH-0003) through the Torque Wrench Barrel. Ensure the Inserter is properly seated on the Locking Cap and rotate clock-wise until the torque limit of the Modular Torque Handle is reached (27in-lbs  $\pm$  10%) (Figure 18).

Once the desired span length and Cross-connector orientation is determined, final tighten the midline cap screw by rotating the Torque Driver (55-IN-0121) until the torque limit of the Modular Torque Handle (55-CH-0003) is reached (27in-lbs  $\pm$  10%).



Figure 17



Figure 18

# SURGICAL TECHNIQUE

## 8

### OCCIPITAL PLATE SIZE SELECTION AND POSITIONING

It is recommended to measure the occipital bone thickness via x-ray to know the appropriate length of the Occipital screw to be used.

The proper plate size should be selected allowing for the placement to be immediately below the level of the inion. (Figure 19)

Size selection should optimize the relationship between the occipital plate tulips and the cervical fixation point.

To maximize bone purchase and to achieve a low profile, the Occipital Plate should be positioned so that it is centered in the midline between the external occipital protuberance and the posterior border of the foramen magnum.

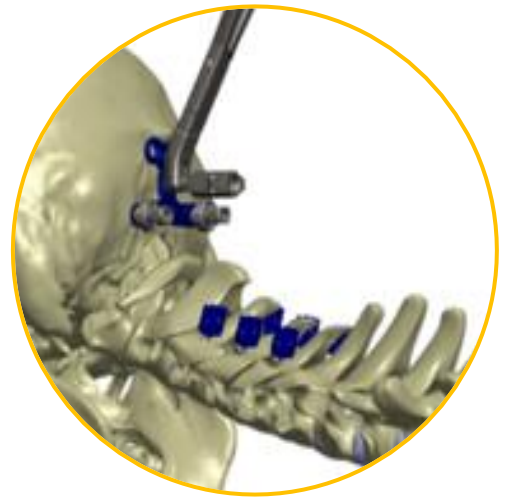

Figure 19

# SURGICAL TECHNIQUE

## 9

## PLATE CONTOURING

There are two options to contour the Occipital Plate.

### OPTION 1

The Bending Iron Short (55-IN-0320) and the Bending Iron Long (55-IN-0322) are used in tandem to contour the plate. The Short Iron has two small ball plungers to grasp the plate and the Long Iron is positioned as close to the contour zone that needs to be bent (Figure 19a and 19b). **Care should be taken to not over-bend the plate in any direction.**

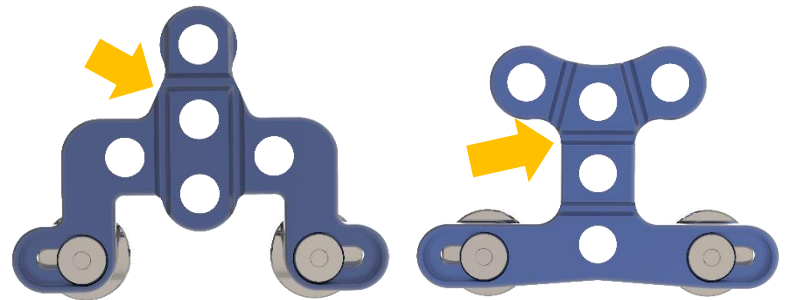
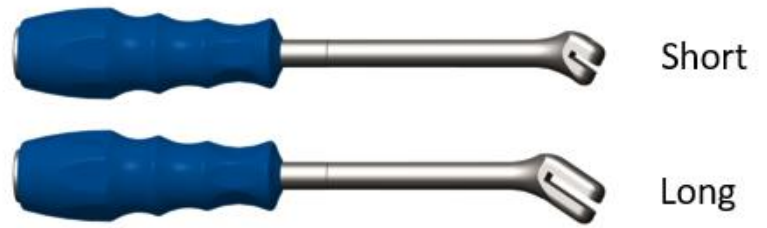

Figure 19a



Figure 19b

### OPTION 2

Position the Occipital Plate on the Occipital Plate Bender (55-IN-0400) Anvil and place the Bender's wedge directly over the contour zone that needs to be bent (Figure 20). Squeeze the Bender's handle to achieve the appropriate contour. **Care should be taken to not over-bend the plate in any direction.**

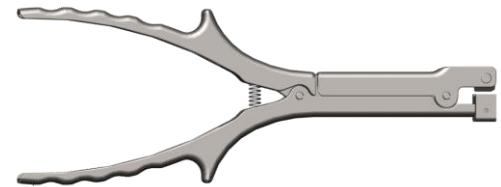

Figure 20



# SURGICAL TECHNIQUE

## 10

### OCCIPITAL PLATE & POLYAXIAL SCREW PLACEMENT

Follow the steps detailed in the Polyaxial Screw Technique above to place Polyaxial Screws in the desired areas.

Select the appropriate Occipital Plate (55-OA-XXXX) and place to the desired area with the All-in-one Plate Inserter and Guide (55-IN-0500) (Figure 21).

Set the depth indication of the Guide to the desired depth and insert the Occipital Bone Drill (55-IN-0520) until fully seated.

#### (OPTIONAL)

The Angled Occipital Bone Drill (55-IN-0530) may be used if necessary.

Remove the Occipital Bone Drill and insert the Occipital Bone Tap (55-IN-0540) until fully seated (Figure 22).

#### (OPTIONAL)

The Angled Occipital Bone Tap (55-IN-0550) may be used if necessary.

Remove the Occipital Bone Tap and insert the appropriate length screw with the Occipital Screw Driver (55-IN-0570) until fully seated.

#### (OPTIONAL)

The Angled Occipital Screw Driver (55-IN-0580) may be used if necessary.

Once the initial Occipital Bone Screw is implanted, the All-in-one Guide and Inserter may be removed.

Repeat steps 3 – 6 for the remaining holes within the Occipital Plate.

#### (OPTIONAL)

The Freehand Occipital Bone Tap (55-IN-0560) and Freehand Occipital Screw Driver (55-IN-0590) may be utilized if necessary.

#### (OPTIONAL)

The Variable Angle Guide (55-IN-0510) can also guide Occipital Bone Drill Placement if desired (Figure 23).

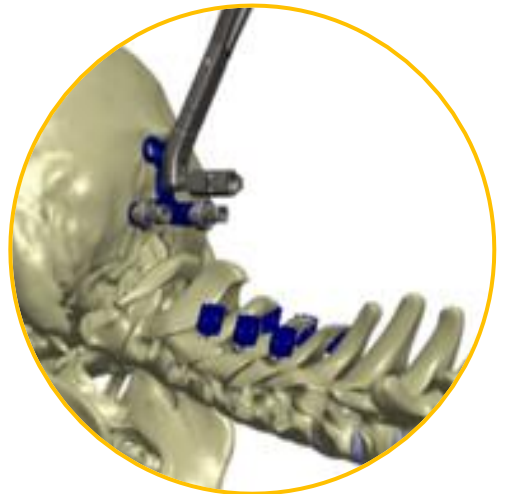

Figure 21

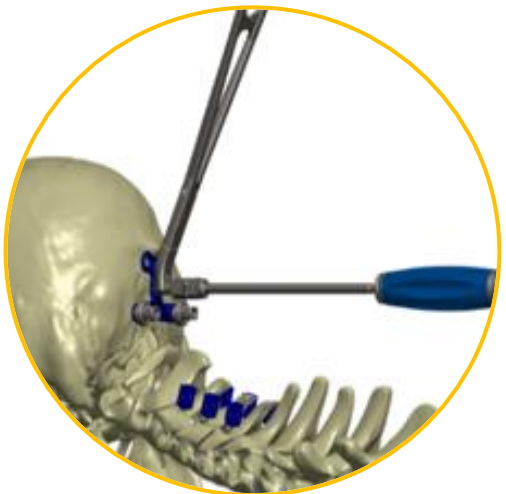

Figure 22

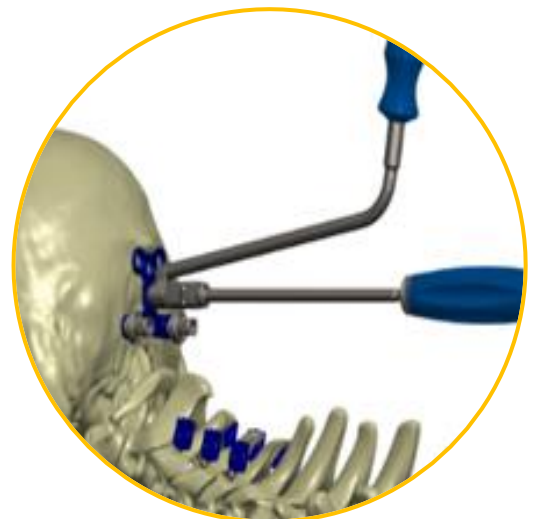

Figure 23

# SURGICAL TECHNIQUE

## 11

### OCCIPITAL ROD PLACEMENT, REDUCTION & FINAL TIGHTENING

Select an appropriately lordosed Pre-lordosed Occipital Rod (55-OR-05-XX, 55-OR-06XX) and insert the Rod so that it fits securely within the Tulip Head of the Occipital Plate and implanted Polyaxial Screws.

#### (OPTIONAL)

The Flexible Rod Template may be used as a guide to aid in selecting the desired Rod lordosis.

#### (OPTIONAL)

The Pre-lordosed Rods are available in various lengths, however, the Rod Cutter (55-IN-0090) may be utilized to shorten a Rod to the desired length. The Rod Pusher (55-IN-0071), Rod Reduction Gun (55-IN-0100), Rod Tower Reducer (55-IN-0114), and Rod Reduction Rocker (55-IN-0110) may be used to assist with assembly of the Rod to the Occipital Plate Tulip and Polyaxial Screw Tulip. Insert a Cap Screw (55-LS-0100) utilizing the Dual Sided Cap Screw Inserter (55-IN-0118) and preliminarily tighten. Repeat for each Occipital Plate Tulip and Polyaxial Screw Tulip.

Final tighten each Cap Screw by assembling the Occipital Counter Torque Wrench (55-IN-0630) to the desired Occipital Plate Tulip and inserting the Torque Driver (55-IN-0121) through the Torque Wrench Barrel (Figure 24). Ensure the Driver is properly seated within the Cap Screw and rotate clock-wise until the torque limit of the Modular Torque Handle (55-CH-0003) is reached (27in-lbs  $\pm$  10%).

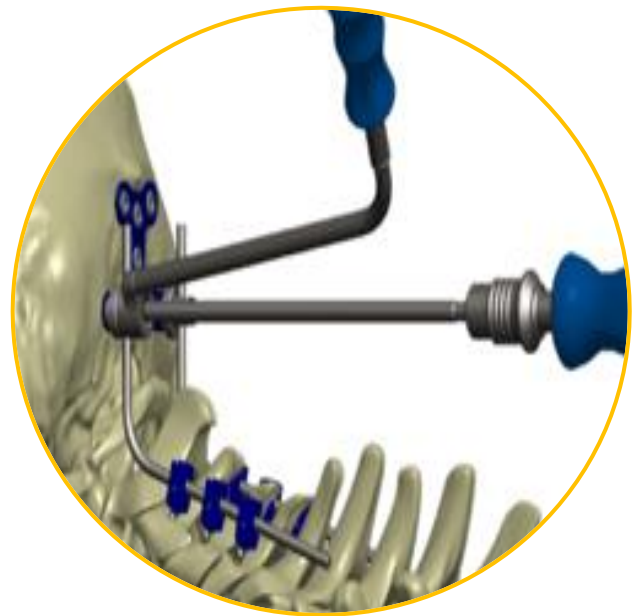

Figure 24

## 12

### SYSTEM REMOVAL

Removal of the Reform® POCT System components is performed by reversing the order of implant procedures.

# INDICATIONS FOR USE

## APPROVED INDICATIONS

The Precision Spine Reform® POCT System is intended to provide immobilization and stabilization of spinal segments as an adjunct to fusion for the following acute and chronic instabilities of the craniocervical junction, the cervical spine (C1 to C7) and the thoracic spine from T1-T3: traumatic spinal fractures and/or traumatic dislocations; instability or deformity; failed previous fusions (e.g., pseudarthrosis); tumors involving the cervical spine; and degenerative disease, including intractable radiculopathy and/or myelopathy, neck and/or arm pain of discogenic origin as confirmed by radiographic studies, and degenerative disease of the facets with instability. The Precision Spine Reform POCT System is also intended to restore the integrity of the spinal column even in the absence of fusion for a limited time period in patients with advanced stage tumors involving the cervical spine in whom life expectancy is of insufficient duration to permit achievement of fusion.

**Please refer to package insert for complete system description, indications and warnings.**

## CONTRAINDICATIONS:

The Reform POCT System contraindications include, but are not limited to:

1. Use in the thoracic-lumbar-sacral spine below T3
2. Patients with osteopenia, bone absorption, bone and/or joint disease, deficient soft tissue at the wound site or probably metal and/or coating intolerance
3. Patients with fever, tumors, elevated white blood count and other medical conditions
4. Obesity
5. Mental Illness
6. Pregnancy
7. Local infection or inflammation
8. Any case needing to mix metals from different components
9. Any patient unwilling to cooperate with postoperative instructions
10. All cases not stated in the indications

## POTENTIAL ADVERSE EFFECTS:

The following potential adverse effects associated with the procedure have been shown to occur with the use of similar spinal systems. All patients considered candidates for fusion should be informed concerning the pathogenesis of their spinal abnormality, the rationale for fusion with instrumentation, and the potential adverse effects. The following are potential adverse effects, but not limited to:

1. Loss of proper spinal curvature, correction, height, and/or reduction
2. Infection
3. Non-Union or delayed union
4. Foreign body reaction to the implants
5. Hemorrhaging
6. Loss of neurological function, dural tear, pain, and/or discomfort
7. Bone graft fracture, vertebral body fracture or discontinued growth of fused bone at, above and/or below the surgery level
8. Bending, loosening, fracture, disassembly, slippage and/or migration of all components
9. Pain or discomfort
10. Change in mental status
11. Bursitis
12. Bone loss and/or bone fracture due to stress shielding
13. Inability to resume normal daily activities
14. Revision surgery
15. Death

## WARNINGS:

The following are warnings for this device.

1. The safety and effectiveness of pedicle screw spinal systems have been established only for spinal conditions with significant mechanical instability or deformity requiring fusion with instrumentation. These conditions are significant mechanical instability or deformity of the thoracic, lumbar, and sacral spine secondary to degenerative spondylolisthesis with objective evidence of neurological impairment, fracture, dislocation, scoliosis, kyphosis, spinal tumor, and failed previous fusion (pseudarthrosis). The safety and effectiveness of these devices for any other condition is unknown.
2. Potential risks identified with the use of this device system, which may require additional surgery, include device component fracture, loss of fixation, non-union, fracture of the vertebrae, neurological injury, and vascular or visceral injury.
3. Benefit of spinal fusions utilizing any pedicle screw fixation system has not been adequately established in patients with stable spines.
4. Single use only. AN IMPLANT SHOULD NEVER BE RE-USED. Any implant, once used, should be discarded. Even though it appears undamaged, it may have small defects and internal stress patterns that may lead to failure. These Single Use devices have not been designed to undergo or withstand any form of alteration, such as disassembly, cleaning or re-sterilization, after a single patient use. Reuse can potentially compromise device performance and patient safety.
5. Failure to achieve arthrodesis will result in eventual loosening and failure of the device construct.
6. To facilitate fusion, a sufficient quantity of autograft bone should be used.
7. Do not reuse implants. Discard used, damaged, or otherwise suspect implants.
8. The implantation of pedicle screw systems should be performed only by experienced spinal surgeons with specific training in the use of pedicle screw spinal systems because this is a technically demanding procedure presenting a risk of serious injury to the patient.
9. Based on the fatigue testing results, the physician/surgeon should consider the levels of implantation, patient weight, patient activity level, other patient conditions, etc. which may impact the performance of the system.
10. The plates, screws, rods, cap screws, cross-connectors, offsets, dominos, hooks, and instruments are sold "NON-STERILE," and therefore must be sterilized before use.
11. The components of this system should not be used with components of any other system or manufacturer.
12. Titanium components should not be used with stainless steel components within the same system.



**Precision Spine, Inc.**

2050 Executive Drive, Pearl, MS 39208

Customer Service: 1.888.241.4773

Phone: 601.420.4244

Toll Free: 877.780.4370

Fax: 601.420.5501

[www.precisionspineinc.com](http://www.precisionspineinc.com)

Caution: Federal (USA) law restricts these devices to sale by, or on the order of, a physician.  
Reform® and Precision Spine® are trademarks of Precision Spine, Inc.  
Copyright 2024 Precision Spine, Inc. All rights reserved. P/N LBL-STG-033 Rev. D 4/2024